

DESIGN OF SYNTHETIC ELEMENTS WITH TRANSIMPEDANCE OPERATIONAL AMPLIFIERS

M. Murina, M. Steinbauer

*Brno University of Technology, Faculty of Electrical Engineering and Communication
Kolejní 2906/4, 612 00 Brno, Czech Republic
e-mail: murina@feec.vutbr.cz, steinbau@feec.vutbr.cz*

Summary One way how to design active filters for wider frequency band is application of transimpedance operational amplifiers (TOAs) based on current mode. For this aim the TOAs exhibit the most suitable properties: large bandwidth, high slew rate, good linearity, high gain, low offset voltage, etc. The paper shows their possibilities for creation of synthetic elements. There will be discussed the relevant problems of synthetic elements above their properties with application of real TOAs. Theoretical relations of synthetic elements calculation will be derived on the base of real TOAs equivalent circuit and possibility of the synthetic elements to design and synthesis of low-sensitivity ARC filters will be shown.

1. INTRODUCTION

Synthetic inductors (SI) are used in many circuits instead of real inductors. Merit of this replacement is in minor size, linearity of parameters and higher quality of inductor. For this aim are widely used immittance converters. The generalized immittance converter (GIC) is usually based on known Antoniou's two Op-Amp circuit (Fig. 1). [1]

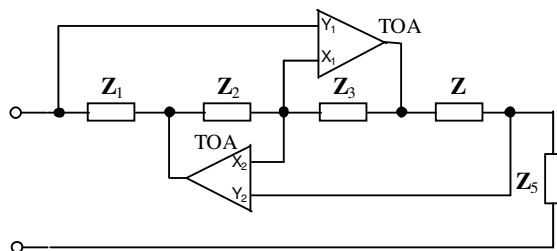

Fig. 1 Generalized immittance converter

Properties of this circuit with classical Op-Amp were described in many references. Nowadays, TOAs can be used for creation of synthetic elements. By application of ideal TOAs in the circuit in Fig. 1 we obtain network with input impedance

$$Z_{id} = \frac{Z_1 Z_3 Z_5}{Z_2 Z_4} \quad (1)$$

Let's turn attention to the inductor simulation. The synthetic inductor (SI) can be obtained by this substitutions:

1. $Z_1 = R_1, Z_2 = 1/sC_2, Z_3 = R_3,$
 $Z_4 = R_4, Z_5 = R_5.$

Interconnection of input X and output of a real TOA by capacitor is a source of instability; hence this substitution will not further be considered.

2. $Z_1 = R_1, Z_2 = R_2, Z_3 = R_3,$
 $Z_4 = 1/sC_4, Z_5 = R_5.$

In this case the network represents a synthetic inductor with impedance

$$Z_{idL} = s \frac{R_1 R_3 R_5}{R_2} C_4 = sL_{id} \quad \text{where} \quad (2)$$

$$L_{id} = \frac{R_1 R_3 R_5}{R_2} C_4. \quad (3)$$

An important question is: how properties of real TOAs affect properties of synthetic elements. For illustration we bring here results that were obtained from simulation of synthetic inductor circuit with TOAs type AD844 by PSPICE program (the library of PSPICE program contains the real model of this device). Supposed element values are:

$$R_1 = R_2 = R_3 = R_5 = 1 \text{ k}\Omega, C_4 = 1 \text{ nF}$$

The obtained frequency dependence of absolute value of SI impedance with real TOAs is in Fig. 2.

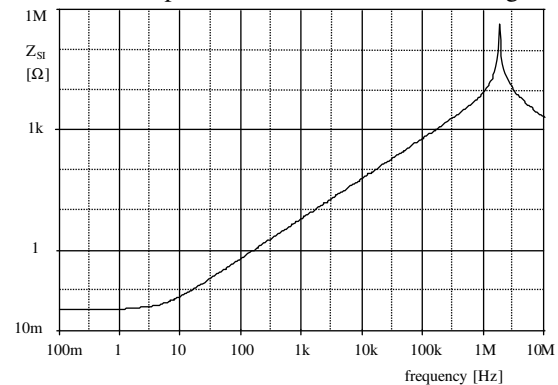

Fig. 2 The frequency dependence of impedance for the synthetic inductor with real TOAs

From Fig. 2 it is evident that SI behaves as a resistor in low frequency range, an inductor in middle frequency range and a parallel resonance circuit in the range of high frequencies. On the base of Fig. 2 we can draw an equivalent scheme for the synthetic inductor shown in Fig. 3. It consists of serial combinations of elements L, Rs, which are connected in parallel with elements Rp and C.

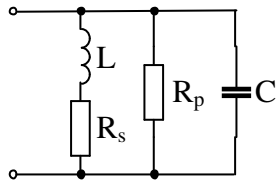

Fig. 3 An equivalent scheme for the synthetic inductor with real TOAs

2. INVESTIGATION OF SI PROPERTIES

The aim of investigation is derivation of formulas for element values of SI equivalent scheme. In the first step the SNAP program was used. It performs the symbolic analysis of circuit functions [2]. SNAP program, however, delivers a very complicated analytic formula of SI impedance, of which it is hard to derive relations for element values of SI equivalent scheme. Analytic expressions describing the effect of real TOAs can be derived only for the simplest cases [3]. At last it was chosen an approximation of PSPICE program numerical results to the relation for element values.

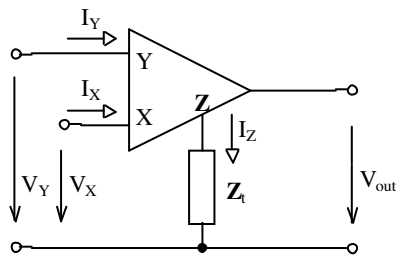

Fig. 4. Ideal TOA.

Ideal TOA (Fig. 4) is described by following formulas

$$I_X = I_Z, \quad I_Y = 0, \quad V_Y = V_X, \quad V_{out} = Z_t I_X, \quad (4)$$

where Z_t is transimpedance ($Z_t \rightarrow \infty$).

Ideal TOA in PSPICE program can be modelled by controlled voltage and current sources with unity gains [4].

Influence of real TIAs properties on synthetic element parameters will be investigated by the equivalent circuit consisting of ideal TOA and added parts. Additional elements $R_{Y1}, R_{Y2}, C_{Y1}, C_{Y2}, R_{T1}, R_{T2}, C_{T1}, C_{T2}$ simulate a finite value of input Y impedance and transimpedance Z_T of TOA₁, TOA₂ and their frequency dependencies. Non-zero input X and amplifier output impedances are modelled by resistors $R_{X1}, R_{X2}, R_{out1}, R_{out2}$ and capacitor C_{X1}, C_{X2} . This equivalent circuit is drawn in Fig. 5. Model elements of the first TOA are here marked by index 1 and model elements of the second TOA by index 2. Verification of the SI model in Fig. 5 was performed by application of TOAs catalogue values to the SI model [5]. Results obtained by SI model and models built in the PSPICE program were identical. Because the PSPICE program works on a base of numerical values it is needed to provide restriction in values of si model elements. At further we will be investigating the SI with identical GIC circuit resistors. For this case we introduce a designation:

$$R_1 = R_2 = R_3 = R_5 = R.$$

In relation to real TOAs parameters derivation of relations will be performed for the following ranges of element values:

$$1 \cdot 10^5 \Omega \leq R_{t1}, R_{t2}, R_{y1}, R_{y2} \leq 1 \cdot 10^7 \Omega,$$

$$1 \Omega \leq R_{x1}, R_{x2}, R_{out1}, R_{out2} \leq 100 \Omega,$$

$$100 \Omega \leq R \leq 10 \text{ k}\Omega,$$

$$1 \text{ pF} \leq C_{x1}, C_{x2}, C_{y1}, C_{y2} \leq 5 \text{ pF},$$

$$2 \text{ pF} \leq C_{t1}, C_{t2} \leq 10 \text{ pF}.$$

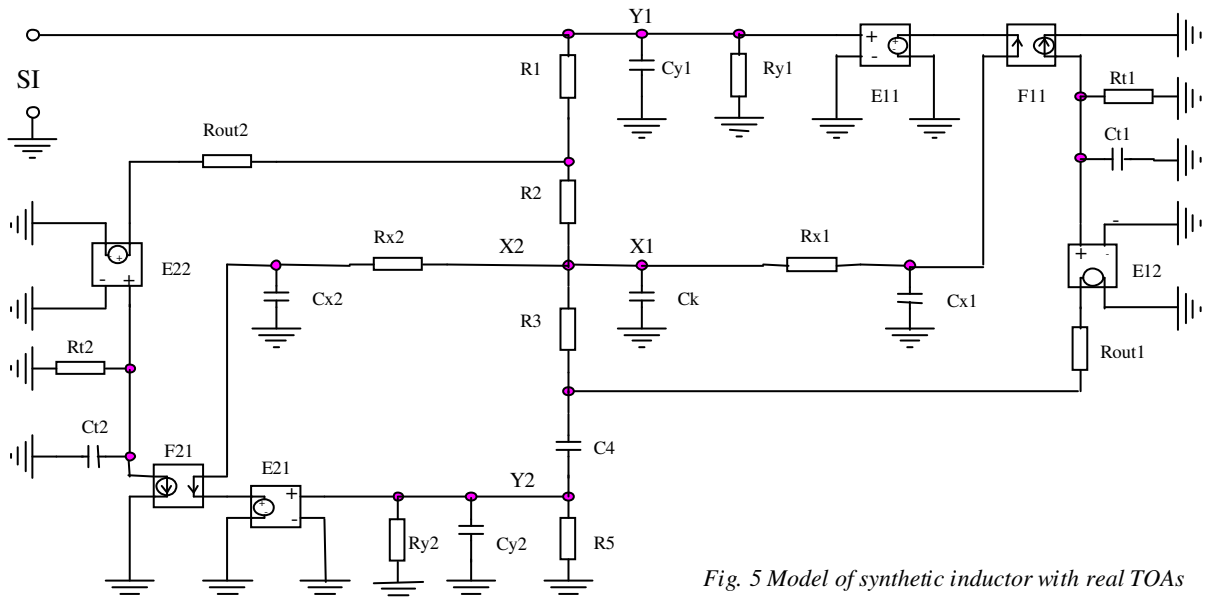

Fig. 5 Model of synthetic inductor with real TOAs

3. DETERMINATION THE VALUES OF SI EQUIVALENT CIRCUIT ELEMENTS

For determination of equivalent circuit values of SI scheme will be below in text used this parametrs of TOAs:

$$R_{t1} = R_{t2} = 1.10^6 \Omega, \quad R_{y1} = R_{y2} = 1.10^7 \Omega,$$

$$R_{x1} = R_{x2} = 50 \Omega, \quad R_{out1} = R_{out2} = 15 \Omega,$$

$$R = 1 \text{ k}\Omega, \quad C_{t1} = C_{t2} = 5 \text{ pF},$$

$$C_{x1} = C_{x2} = C_{y1} = C_{y2} = 2 \text{ pF}.$$

The result of investigation is a high quantum of data. For illustration we introduce here some partial results. In this case the value of capacitor $C_4 = 100 \text{ nF}$ was chosen. The influence of a finite value of resistor R_{t1} illustrates Fig. 6. The dependences in Fig. 6 show that the value of resistor R_s decreases and that of resistor R_p increases with increasing of resistor R_{t1} .

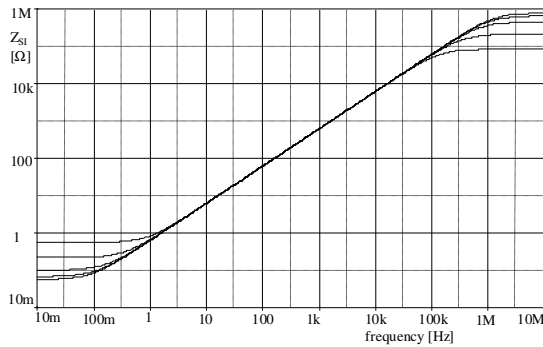

Fig. 6 The influence of transresistor value R_{t1} on frequency dependence of SI impedance

Tab. 1 shows an influence of R_{t1} resistor values on values of resistors R_{st1} , R_{pt1} . Here the index “t1” indicates the influence of resistor R_{t1} .

Tab. 1

R_{t1} [MΩ]	0.1	0.3	1	3	10
R_{st1} [mΩ]	554	220	102	69	57
R_{pt1} [kΩ]	84.8	213	451	661	790

On base of total inspection of numerical and graphical results approximate relations for calculation of SI equivalent scheme element values were derived.

The resistor R_s value is dependent on values of resistors R , R_t , R_x , R_{out} . This dependence can be described by following relation

$$R_s = \frac{(R_{x1} + R_{x2}) \cdot (R_{t1} + R_{t2})}{2R_{t1} \cdot R_{y2}} \cdot [R + 0.75(R_{out1} + R_{out2})], \quad (5)$$

In described case of the circuit the values resistors in operational network are the same, so we obtain from (3):

$$L = R^2 C_4. \quad (6)$$

Now we take into account that the TOA_2 input resistor R_{y2} is connected in parallel with the resistor R_5 (Fig. 5). This configuration we replace by resistor

$$R' = \frac{R \cdot R_{y2}}{R + R_{y2}}. \quad (7)$$

The capacitor C_{y2} is connected in parallel with the resistor R' . The resistor R' value is relatively low in comparison with the capacitor C_{y2} reactance therefore an effect of capacitor C_{y2} is practically insignificant and the SI inductance can be calculated from the relation

$$L = RR'C_4 = \frac{R^2 R_{y2}}{R + R_{y2}} C_4. \quad (8)$$

The non-zero values of resistors R_{x1} , R_{x2} and the finite value of resistor R_{t1} , R_{t2} create the resistor

$$R_{pxt} = \frac{R_{t1} \cdot R_{t2}}{R_{t1} + R_{t2}} \cdot \frac{R}{R + 0.5(R_{x1} + R_{x2})} \quad (9)$$

which is connected in parallel to the L . The first part of the term (9) presents influence of the resistors R_{t1} , R_{t2} and the second part shows the influence of the resistors R , R_{x1} and R_{x2} . From Fig. 5 it is evident that the TOA_1 input resistor R_{y1} creates a parallel circuit with the resistor R_{pxt} . Consequently we can express the R_p resistor value by relation

$$R_p = \frac{R_{pxt} \cdot R_{y1}}{R_{pxt} + R_{y1}}. \quad (10)$$

An investigation of the influence of TIAs “parasitic” capacitances brings an interesting discovery, which it leads to relations for capacitances

$$C = C_{t1} + C_{t2} + C_{y1} - C_{x1} - C_{x2}. \quad (11)$$

4. DETERMINATION OF WORKING AREA

Working area of SI starts under condition

$$R_s = 2\pi f_d L \quad (12)$$

which is fulfilled on frequency

$$f_d = R_s / 2\pi L. \quad (13)$$

For high frequency this working area is limited due parallel resonance. Resonant frequency of the parallel circuit is

$$f_r = \frac{1}{2\pi\sqrt{LC}}. \quad (14)$$

It is interesting to note that addition of capacitor C_k (see Fig. 5) has an effect similar to the increase of

capacitance C_{x1} or C_{x2} . Thus, due to (11) and (14) the resonant frequency can be increased.

This phenomenon will occur for

$$C_k \leq C_{kmax} \quad (15)$$

where

$$C_{kmax} = C_{t1} + C_{t2} + C_{y1} - C_{x1} - C_{x2} \quad (16)$$

Now we will show on example of SI with inductance $L=0.1$ H the possibility of resonant frequency increasing. In this case C_{kmax} value is:

$$C_{kmax} = C_{t1} + C_{t2} + C_{y1} - C_{x1} - C_{x2} = 8 \text{ pF.}$$

Corresponding numerical results of capacitor C_k versus resonant frequency f_r and resistor R_p values are in Tab. 2. Fig. 7 shows the corresponding curves for capacitor C_k values

Tab. 2

C_k [pF]	f_r [kHz]	R_p [k Ω]
0	173.8	439.8
4	289.9	442.4
6	327.3	447.1
8	901.6	516.7
10	398.1	120
12	266.1	81.7

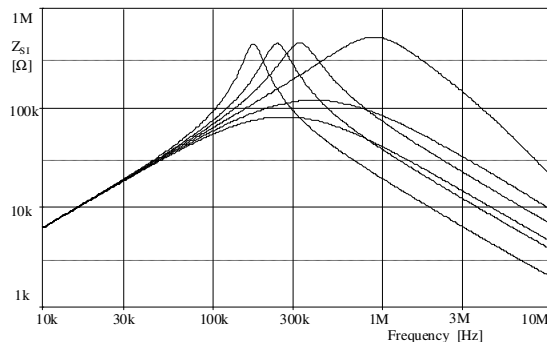

Fig. 7 The influence of capacitor C_k value on a resonant frequency

5. DESIGN OF SI

Taking advantage of relations derived above we can design SI with respect to real properties of TOAs. We can include tolerance of parameters into calculation; application of described theory we now show on SI design of inductance $L = 10$ mH.

Used TOA AD844 has equivalent circuit element values [5]: $R_X = 50 \Omega$, $R_Y = 10 \text{ M}\Omega$, $C_Y = 2$ pF, $R_T = 3 \text{ M}\Omega$, $C_T = 4.5$ pF, $R_{out} = 15 \Omega$.

Lets choose value of $R = 500 \square$. Neglecting value of R_{y2} we can write using (8)

$$C_4 = \frac{L}{R^2} = 40 \text{ nF.}$$

Now we can compute values of remaining parts in schematic Fig. 3 using (5), (10), (11):

$$R_s = \frac{(R_{x1} + R_{x2}) \cdot (R_{t1} + R_{t2})}{2R_{t1} \cdot R_{y2}} \cdot [R + 0.75(R_{out1} + R_{out2})] = 17.42 \text{ m}\Omega,$$

$$R_{pxt} = \frac{R_{t1} \cdot R_{t2}}{R_{t1} + R_{t2}} \cdot \frac{R}{R + 0.5(R_{x1} + R_{x2})} = 1.364 \text{ M}\Omega,$$

$$R_p = \frac{R_{pxt} \cdot R_{y1}}{R_{pxt} + R_{y1}} = 1.364 \text{ M}\Omega,$$

$$C = C_{t1} + C_{t2} + C_{y1} - C_{x1} - C_{x2} = 7 \text{ pF.}$$

Working area of this SI has lower and upper frequency limits (13), (14)

$$f_d = \frac{R_s}{2\pi L} = 0.2772 \text{ Hz,}$$

$$f_r = \frac{1}{2\pi\sqrt{LC}} = 601.5 \text{ kHz.}$$

6. CONCLUSION

Real TOAs influence the characteristics of synthetic elements. Analytic expressions describing the effect of real TOAs can be derived only for the simplest cases.

In this paper there were derived relations of synthetic inductor calculation on the base of an SI model with real TOAs equivalent circuit. For this aim there was used the program PSPICE v. 9.2, which generated vast amount of data. Gained data were a base for creation of approximate relations, which enabled real SI parameter calculation from TOAs catalogue data. These relations establish simple criteria for optimum selection of TOA type in association with required properties of synthetic inductors.

Acknowledgement

This work was financially supported by the research plan MSM 0021630513.

REFERENCES

- [1] GHAUSI, M. S.: *Analog Active Filters* IEEE Transaction on Circuits and Systems, vol. CAS-31, no.1, pp.13-29, January 1984.
- [2] BIOLEK, D. – KOLKA, Z.: *Program SNAP v.2.6 : New possibilities for education and Investigation (in Czech)*. Proceeding of Circuit theory seminar STO 7 Brno 1999, pp. 66-69.
- [3] TICHÁ D., - MARTÍNEK, P.: *Transimpedance Amplifiers in GIC-based Filters Structures*. Proceeding of the Conference Radio electronics, Brno 1999, pp. 25-28.
- [4] DOSTÁL, T.: *Insensitive Voltage-mode and Current-mode Filters from Transimpedance Opams*. IEEE Proc. - Circuits Devices Syst., Vol. 142, No. 2, pp. 140-143, April 1995
- [5] *Monolithic Op Amps, Analog Devices Catalog*